

Product Overview

This data logger is mainly used to record the temperature of food, pharmaceuticals and chemicals, etc. in the storage and transportation. It is especially applicable to container transportation of temperature sensitive goods by sea, air and road for large export-oriented enterprises and global chain enterprises.

Technical parameters

Recording Options: Multi-Use
Temperature Range: -30°C to 70°C
Temperature Accuracy: ±0.5(-20°C/+40°C); ±1.0(other range)
Temperature Resolution: 0.1°C
Data Storage Capacity: 32,000 readings
Shelf Life/Battery: 2 years/CR14250 button cell
Recording Interval: 15 minutes(standard)
Startup Mode: Button or software
Stop Mode: Button, software or stop when full
Protection Class: IP67
Certifications: EN12830, CE, RoHS
Validation Certificate: Hardcopy and PDF file in memory
Software: PDF /ElitechLog Win or Mac (latest version)
Report Generation: Automatic PDF report
Password Protection: Optional on request
Connection Interface: USB 2.0, A-Type
Alarm Configuration: Optional, up to 5 points
Reprogrammable: With free Elitech Win or MAC software
Dimensions: 131mmx24mm(LxD)
Weight: 60g

1. Depending on optimal storage conditions(±15°C to +23°C/45% to 75% rH)

Use the data logger for the first time

Install the software first. Insert data logger to computer USB port and install the drive software according to the prompt information. Open the software; the data logger will automatically upload information after connected to the computer. View information and save the configuration to calibrate the time.

Configure parameters

Refer to the data management software instruction for details. When connected to USB, the data logger displays Figure 19.

Start the data logger

There are three modes to start it—instant-on, manual start, and timing start.

Instant-on: After parameter configuration, the data logger starts recording immediately when it disconnects to USB.

Manual start: After parameter configuration, press and hold the button for 5 seconds to start the data logger. In this mode, it has start delay function. If this function is enabled, the data logger will not record data immediately after start-up but start recording after the set delay time elapses.

Timing start: After parameter configuration and disconnection with USB, the data logger starts recording when it reaches the set time.

View data temporarily

If you need to view simple statistical information, you may directly press the button to turn page and check. The LCD screen can display MKT, average value, Max value and Min value.

If you need detailed information, please connect the data logger to computer USB. After a few min (in 3 min), the data will be saved in the USB disk of the data logger in PDF format report.

You can connect the data logger to a computer and analyze the data vertically and horizontally by the data management software.

Stop the data logger

There are several modes to stop it—manual stop, over-Max-record-capacity stop (enable/disable manual stop), stop via software.

Manual stop: When the data logger is recording in this mode, you may press and hold the button for 5 second to stop it. You can also use the software to stop it. If the record capacity reaches the Max value (32000 points) and the data logger is not stopped manually. The data logger will save the data circularly by deleting the initial data. (It keeps the statistical information of the whole transportation process)

Note: When the record capacity exceeds the Max capacity (32000 points) in the manual mode, the data logger can continue recording the temperature state of the whole transportation process but only keep the detail of the last 32000 points. Please use the “manual stop” mode with caution if you have demand of tracing back the detail of the whole process.

Over-Max-record-capacity stop (enable manual stop): In this mode, you can stop the data logger by hand or via software, or it will stop automatically when the record data reaches the Max capacity (32000 points).

Over-Max-record-capacity stop (disable manual stop): In this mode, it will stop automatically when the record data reaches the Max capacity (32000 points), or you stop it via software.

Stop via software: You can stop the data logger via software in any mode.

View data

Connect the data logger to the computer via USB and then view the data.

View PDF report: Open the USB disk to view the exported PDF report.

View report via the data management software: Open the software and import the data, the software will display the configuration info and record data.

Display menu instruction

The data logger displays different pages based on the settings. Below is the Max display info. If you do not set relative info, it will not appear in page turning.

Menu 1: Start delay time or the remaining time of timing start (Hr: Min. 10Sec, e.g. the digit N following the decimal point represents N*10 sec. Fig.2 shows 10 min 20 sec left for the logger to start.) This page is displayed only in start delay or timing start status.



Fig.1 In timing start



Fig.2 In start delay (▶ flashing)

Menu 2: Current temperature. See Fig. 3, 4 (Static ▶ indicates it is recording.)



Fig.3 Current temperature (No alarm occurred)



Fig.4 Current temperature (Alarmed)

Menu 3: Current record points. See Fig.5 (Static □ indicates the current record points exceed the Max capacity and the data logger recorded circularly.)



Fig.5 Current record points

Menu 4: Current record interval. See Fig.6 (e.g. if the digit N following the decimal point represents N*10 sec. Fig.6 shows the record interval is set to 12 min 50 sec.)



Fig.6 Record interval

Menu 5: MKT value. See Fig.7 (Static ■ indicates it stops recording.)



Fig.7MKT value

Menu 6: Average temperature value. See Fig.8

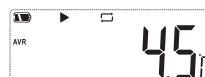

Fig.8 Average temperature value

Menu 7: Max temperature value. See Fig.9



Fig.9Max temperature value

Menu 8: Min temperature value. See Fig.10



Fig.10 Min temperature value

Menu 9,10,11: Set upper limit of temperature. See Fig.11,12,13



Fig.11 Upper limit 3



Fig.12 Upper limit 2



Fig.13 Upper limit 1

Menu 12,13: Set lower limit of temperature. See Fig.14,15

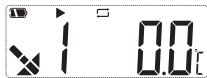

Fig.14 Lower limit 1



Fig.15 Lower limit 2

Other status



Fig.16 Deleting data



Fig.17 Recovering data (Power on)



Fig.18 Generating report (the figure: process identifier)



Fig.19 USB connection

Step 2. Press the snap to remove the compartment. See Fig.21

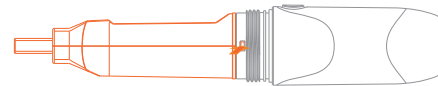
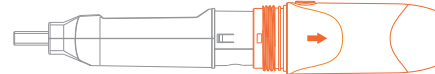
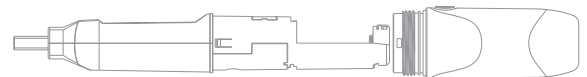

Fig.21 Press the snap

Step 3. Remove the battery compartment. See Fig.22



Step 4. Install and replace the battery. See Fig.23



Step 5. Adjust the button and the internal light pipe to the same side, snap the compartment shut. See Fig.24



Step 6. Rotate the transparent cap to install it in the direction shown in Fig.25.

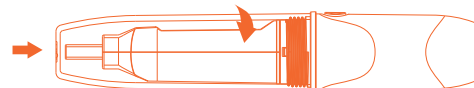

Content of PDF report

The PDF document varies based on the set alarm types. When it is set to "no alarm", there is no alarm info on the top right corner of the first page or color mark among data. When it is set to "alarm", relative alarm info appears in the alarm info column based on the selected alarms. Over high temperature data is in red. Over low temperature data is in blue. Normal data is in black. If alarm cases occur, there will be marked as alarm status on top right corner of the first page, otherwise, it is in normal status.

Finish view

Exit the data logger after viewing the report.

Product diagram

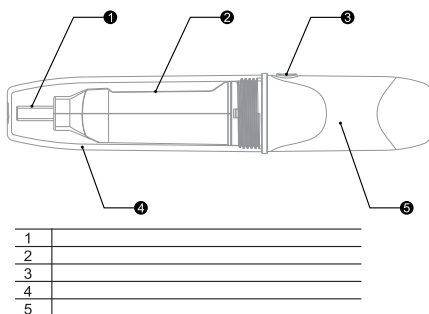

Replace the battery

Step 1. Rotate the transparent cap and remove it in the direction shown in Fig.20.

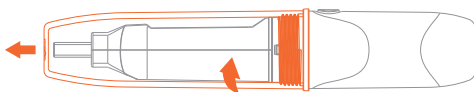

Standard configuration

- 1 piece of RC-51 temperature data logger
- 1 piece of user manual

Elitech Technology, Inc.
 www.elitechlog.com
 1551 McCarthy Blvd, Suite 112
 Milpitas, CA 95035 USA